



Ver 7.0

유럽 최고의 기술력으로 생산되는

# CS ROOF TILE

## CS 기와



[www.cs-rooftiles.co.kr](http://www.cs-rooftiles.co.kr)





# CS

미려한 디자인의  
유럽 점토기와

# ROOFTILES

---

F3+	05
F5 (Global)	09
D3+	13
Plasma	17
Plasma TX5	21
Canudo	27
Portfolio 시공사례	31
Accessory 부속기와	51
Accessory 부속자재	53
JH-GUTTER 물받이 시스템	55
기와커팅기	57

---



# CS COMPANY HISTORY

원스톱 생산 유통망을 갖춘 CS Company는 연구와 기술 개발에 앞장서는 기업으로, NP EN ISO9001:2000 인증을 획득하고 있습니다.



## NO.1

유럽지붕재  
기와생산  
부속자재생산

### 1927~1940

1차 도약\_ 점토 기와분야의 'COELHO DA SILVA'로 명성을 날리기 시작하였습니다.

### 1950~1960

2차 도약\_ 제1공장과 기와 F1 제품 일관 생산기술을 완성하였습니다.

### 1980~1990

중흥기\_ 유럽에서 기와 부문의 선도기업으로 발전해 나갔으며, 특히 자동화된 생산기술과 신제품인 기와 F2, F3를 생산하기 시작하였습니다. 그 후 포르투갈 및 유럽지역에서 최고의 기술력과 생산능력을 보유한 회사로 성장하게 되었습니다.

### 2000년대 이후

최고의 성장세 지속\_ 신제품 F4, F5를 출시하고, Tecno, Domus 및 Plasma 등 잇따라 최고의 제품을 선보였습니다. 기와의 전 자동화 생산체제를 이룩하였고, 방수 및 고온처리 등에서의 최신기술을 도입하는 등 최상의 디자인과 기능을 갖춘 제품을 생산, 공급하고 있습니다.



CS기와  
세계최대 규모  
단일공장  
(5개 공장)

## CS기와의 생산방식

모듈 : 금속형(합성고무) < 석고형 (금속형 보다 더 완벽한 Inter-Locking 구현)



건조 및 오븐 : No카셋 < U카셋 < H카셋 (H카셋- 균질한 열의 전달로 제품의 퀄리티가 우수)







# F3+<sup>®</sup>

지중해의 아름다움을 담은  
스페니쉬 S형 기와

힘강도  
EN 538

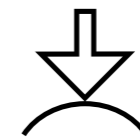

불침투성  
EN 539-1



동결저항성  
EN 539-2

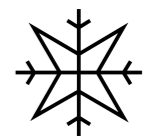

정밀도  
EN 1024

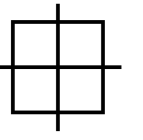



# F3+®

## 지중해의 아름다움을 담은 스페니쉬 S형 기와



- U카셋 적용
- 정밀한 Inter-Locking: 방수, 차수, 방풍 성능 우수
- 긴결성 우수: 집중호우 등 악천후에 탁월한 방호 효과

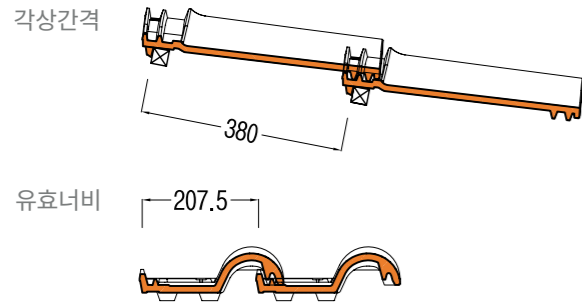

크기	459 x 266 mm
무게	3.8 Kg
각상간격	385 mm
유효너비	207 mm
㎡당 기와수	Min: 12 / Max: 13.2 장
㎡당 무게	약 45.6 ~ 50.2 Kg
좌/우갓	2.6 장/m
용마루	2.5 장/m

## PRODUCT SPECIFICATIONS

항목	적용기준	표준 요구사항
힘강도 Flexural strength	EN 538	저항>1200N
불침투성 Impermeability	EN 539-1	(Method 2) Category 1
동결저항성 Frost resistance	EN 539-2	유럽 단일 시험 방법 저항 - Level 1 (≤150 cycles)
동결저항성 Frost resistance	EN 1024	평면도≤=1.5% 직선성≤=1.5%

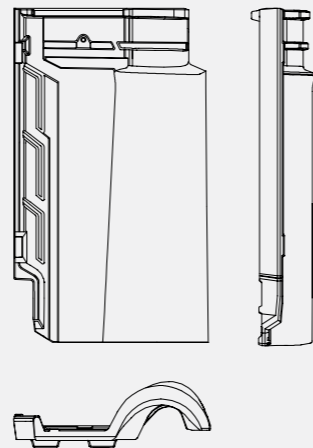

## PRODUCT COLORS

제품 색상



Nile 네일



Natural Red 적색



Vieille Terre 벨라테라



Natural Brown 밤색



Mediterranean Rustic 메디테리언





# F5<sup>®</sup> Global

## 최상의 퀄리티로 진보된 스페니쉬 S형 기와

힘강도  
EN 538

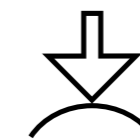

불침투성  
EN 539-1



동결저항성  
EN 539-2

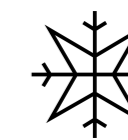

정밀도  
EN 1024

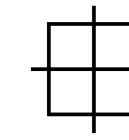



## 최상의 퀄리티로 진보된 스페니쉬 S형 기와



- H카셋, 석고형틀 적용
- 정밀한 치수 유지를 위한 **플라스터 몰딩 공법 적용**
- **하이드로 캐스팅 공법 적용**으로 점토의 투과성을 월등히 감소시켜 가혹한 환경조건에 대한 내성을 증대시킴

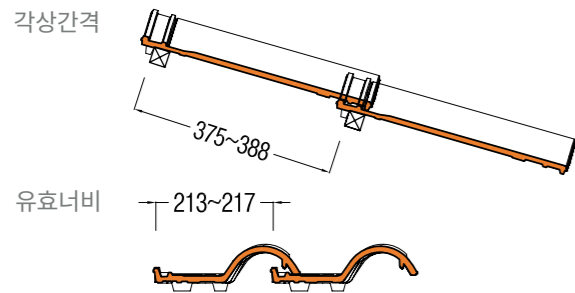

크기	445 x 262 mm
무게	3.6 Kg
각상간격	372 ~ 392 mm
유효너비	213 mm
㎡당 기와수	Min: 11.9 / Max: 12.9 장
㎡당 무게	약 42.8 ~ 46.4 Kg
좌/우갓	2.6 장/m
용마루	2.5 장/m

### PRODUCT COLORS

제품 색상



Rustic Natural 오지변색



Titanium 검정색

### PRODUCT SPECIFICATIONS

항목	적용기준	표준 요구사항
힘강도 Flexural strength	EN 538	저항>1200N
불침투성 Impermeability	EN 539-1	(Method 2) Category 1
동결저항성 Frost resistance	EN 539-2	유럽 단일 시험 방법 저항 - Level 1 (≤150 cycles)
동결저항성 Frost resistance	EN 1024	평면도≤1.5% 직선성≤1.5%

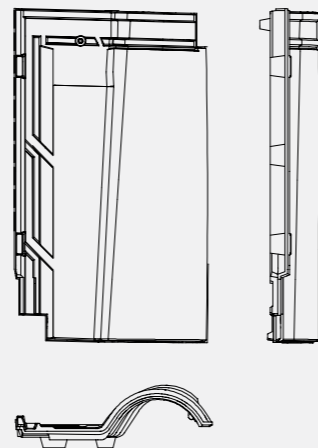

Europe 유폴피언



Mediterranean Rustic 메디테리언





# D3+<sup>®</sup>

프랑스 남부지방의 정취를 담은  
유럽전통의 평기와

휨강도  
EN 538

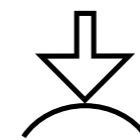

불침투성  
EN 539-1



동결저항성  
EN 539-2

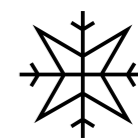

정밀도  
EN 1024

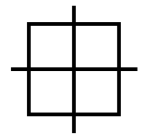



# D3+®

## 프랑스 남부지방의 정취를 담은 유럽전통의 평기와



- H카셋 적용
- 시공의 편의성: 각상간격의 유동적인 조절가능
- 우수한 배수능력: 낮은 경사의 지붕 시공가능

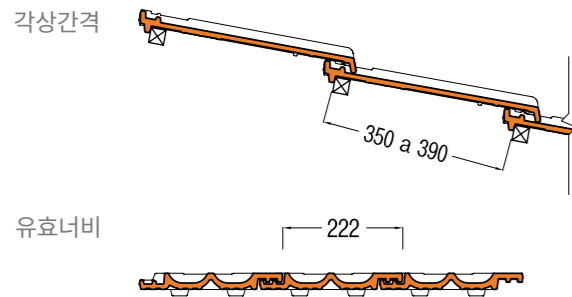

크기	445 x 267 mm
무게	3.7 Kg
각상간격	350 ~ 390 mm
유효너비	222 mm
㎡당 기와수	Min: 11.4 / Max: 13 장
㎡당 무게	42.2 ~ 48.1 Kg
좌/우갓	2.5 장/m
용마루	2.5 장/m

### PRODUCT COLORS

제품 색상



Rustic Natural 오지변색



Aged 에이지드 (주문품)

### PRODUCT SPECIFICATIONS

항목	적용기준	표준 요구사항
힘강도 Flexural strength	EN 538	저항>900N
불침투성 Impermeability	EN 539-1	(Method 2) Category 1
동결저항성 Frost resistance	EN 539-2	유럽 단일 시험 방법 저항 - Level 1 ( ≤150 cycles)
동결저항성 Frost resistance	EN 1024	평면도≤1.5% 직선성≤1.5%

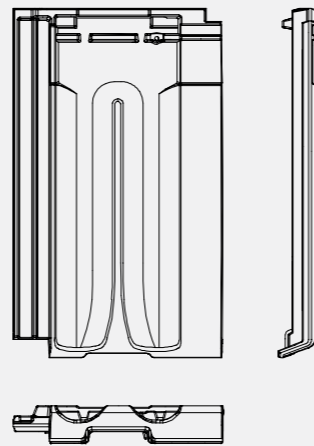

Natural Red 적색 (주문품)



Anthracite 검정색 (주문품)





# Plasma®

모던하우스에 어울리는  
CS의 프리미엄 평기와

휨강도  
EN 538

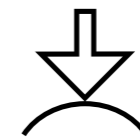

불침투성  
EN 539-1



동결저항성  
EN 539-2

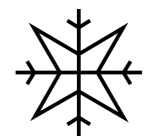

정밀도  
EN 1024

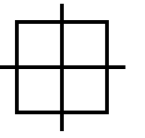



# Plasma®

## 모던하우스에 어울리는 CS의 프리미엄 평기와



- H카셋, 석고형틀 적용 / 지붕 및 벽체 시공가능
- 플라스틱 몰딩 공법 / 하이드로 캐스팅 건조공법 적용
- 一자 방식, 지그재그 방식 모두 시공가능

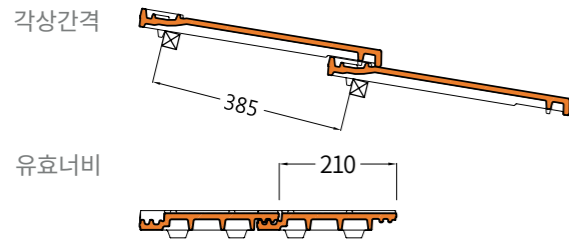

크기	487 x 251 mm
무게	4.0 Kg
각상간격	385 mm
유효너비	210 mm
㎡당 기와수	Min: 11.8 / Max: 12.7 장
㎡당 무게	47.2 ~ 50.8 Kg
좌/우갓	2.5 장/m
용마루	2.5 장/m

## PRODUCT SPECIFICATIONS

항목	적용기준	표준 요구사항
힘강도 Flexural strength	EN 538	저항>900N
불침투성 Impermeability	EN 539-1	(Method 2) Category 1
동결저항성 Frost resistance	EN 539-2	유럽 단일 시험 방법 저항 - Level 1 (≤150 cycles)
동결저항성 Frost resistance	EN 1024	평면도≤1.5% 직선성≤1.5%

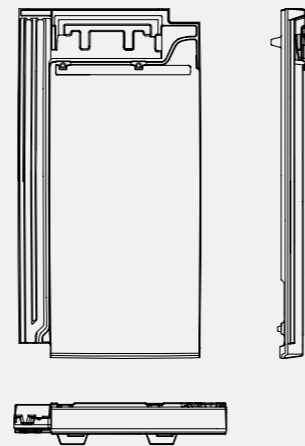

## PRODUCT COLORS

제품 색상

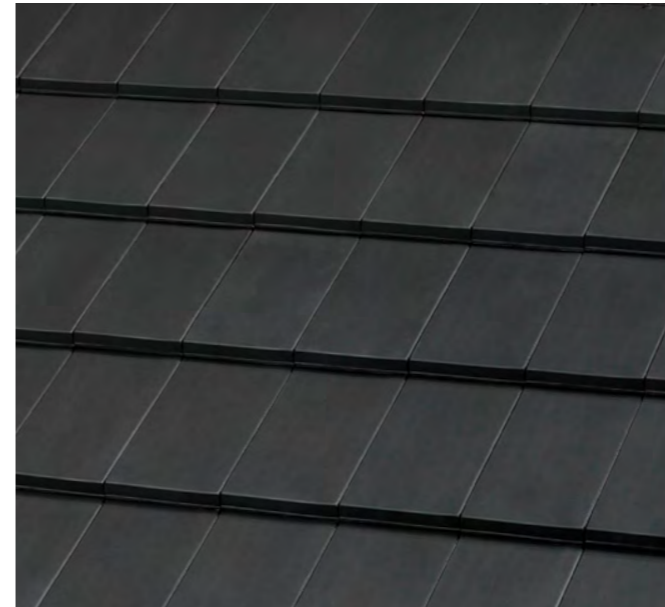

Anthracite 검정색



Natural Red 적색 (주문품)



Copper Green 녹색 (주문품)



SNOW STOP 스노우 스탱 (부자재)





# Plasma<sup>(↷)</sup> TX5

고풍스러운 디자인의  
자연을 담은 점토 평기와

힘강도  
EN 538

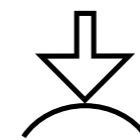

불침투성  
EN 539-1



동결저항성  
EN 539-2

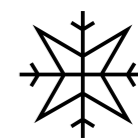

정밀도  
EN 1024

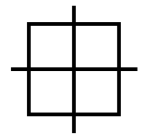



# Plasma<sup>®</sup> TX5

고풍스러운 디자인의  
자연을 닮은 점토 평기와



- H카셋, 석고형틀 적용 / 지붕 및 벽체 시공가능
- 플라스터 몰딩 공법 / 하이드로 캐스팅 건조공법 적용
- 一자 방식, 지그재그 방식 모두 시공가능

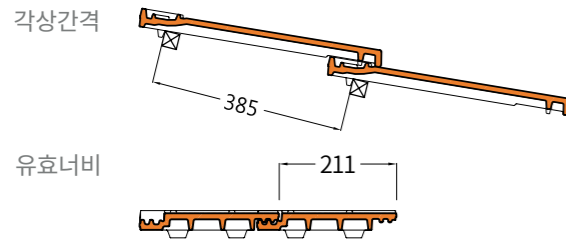

크기	487 x 251 mm
무게	4.0 Kg
각상간격	385 mm
유효너비	211 mm
㎡당 기와수	Min: 11.8 / Max: 12.7 장
㎡당 무게	47.2 ~ 50.8 Kg

## PRODUCT SPECIFICATIONS

항목	적용기준	표준 요구사항
힘강도 Flexural strength	EN 538	저항>900N
불침투성 Impermeability	EN 539-1	(Method 2) Category 1
동결저항성 Frost resistance	EN 539-2	유럽 단일 시험 방법 저항 - Level 1 (≤150 cycles)
동결저항성 Frost resistance	EN 1024	평면도≤1.5% 직선성≤1.5%

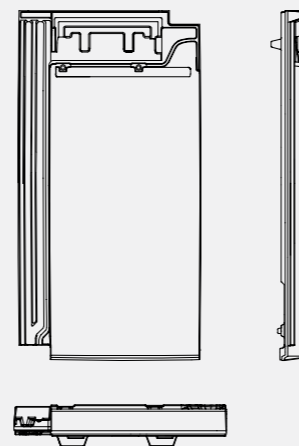

## PRODUCT COLORS

제품 색상



Slate 회색



Anthracite 검정색 (주문품)





## 모던한 디자인의 Plasma 기와와 메탈 후레싱의 만남

Plasma 평기와는 모던한 디자인의 건축물에 적용하기 매우 좋은 모습을 하고 있습니다. 다양한 건축미에 대한 요구에 따라 Plasma 평기와의 마감부 처리를 메탈 후레싱을 사용하여 깔끔하고 완결성 있는 지붕을 완성시킬 수 있습니다. Plasma TX5의 독특한 질감이 그대로 살아 있는 메탈 후레싱을 사용하여 디자인의 완결성을 지킬 수 있으며 여타 색상의 Plasma 평기와도 그에 맞는 색상의 메탈 후레싱을 이용하여 통일성 있는 디자인을 실현할 수 있습니다.

재질	오리지널 징크 / 반무광 알루미늄 / 갈바
두께	0.5T / 0.7T
색상	Slate / 검정색 / 회색 / 적색 / 녹색



## 마감부 후레싱 처리 공법

### 용마루 후레싱 적용 상세도

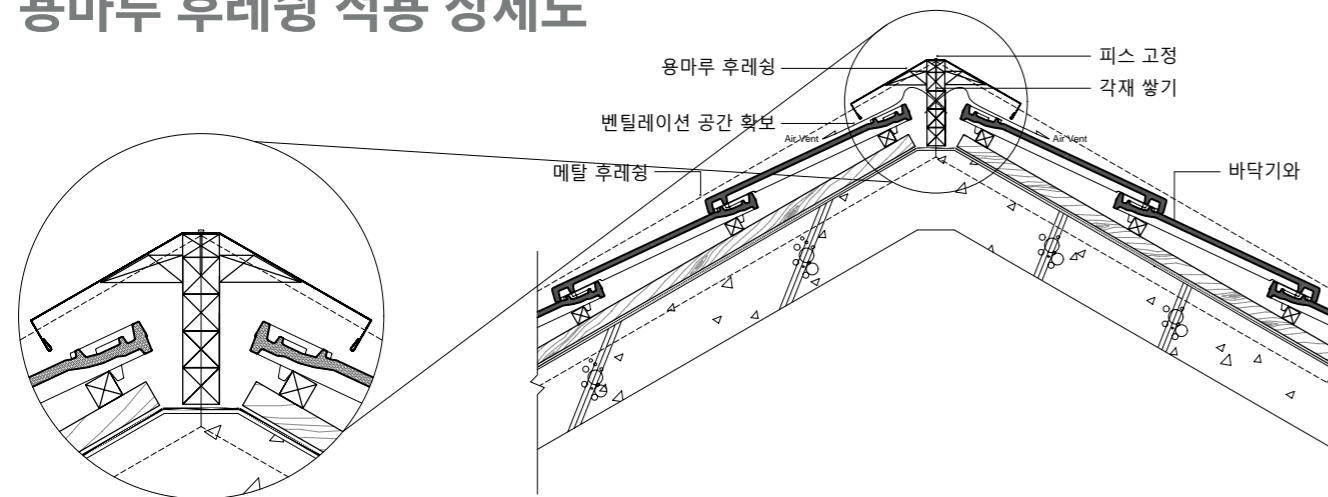

용마루 후레싱 적용 3D 투시도

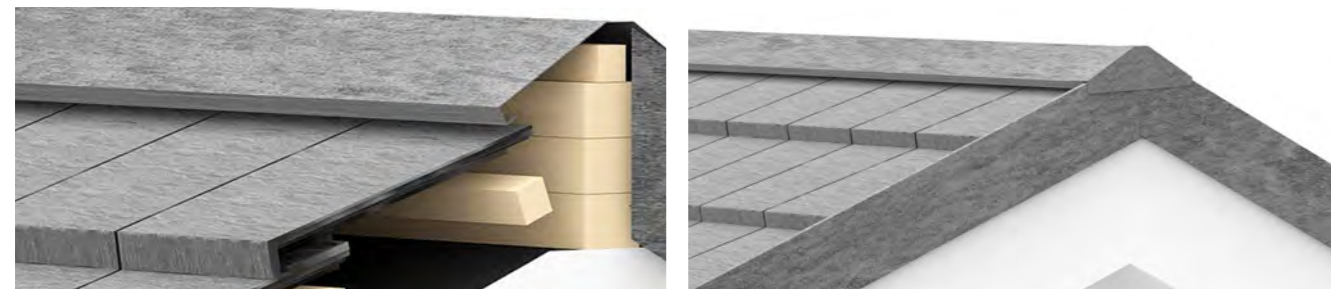

### 측면 후레싱 적용 상세도

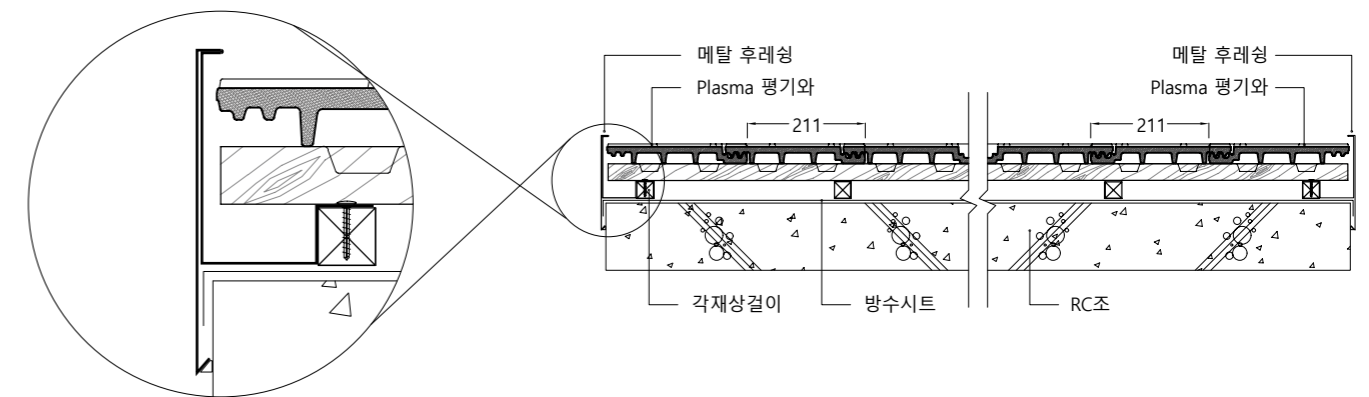

측면 후레싱 적용 3D 투시도

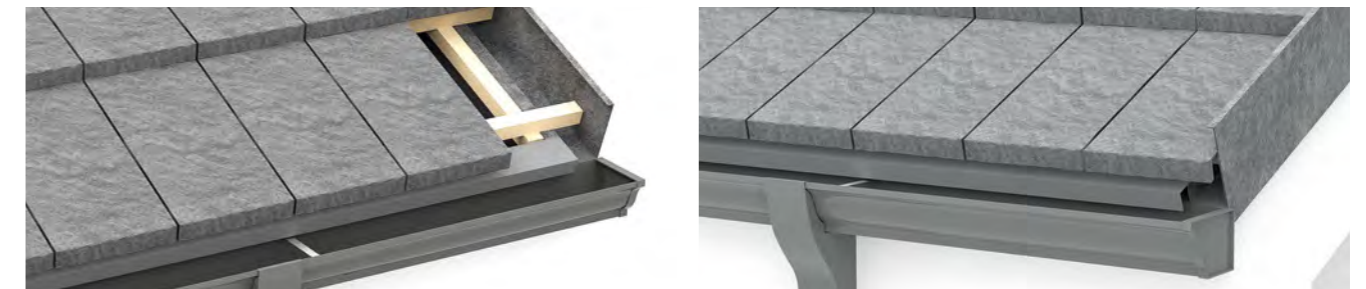





# Canudo<sup>®</sup>

과거의 아름다움을 담은  
U형 기와

힘강도  
EN 538

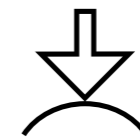

불침투성  
EN 539-1



동결저항성  
EN 539-2

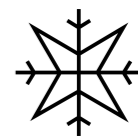

정밀도  
EN 1024

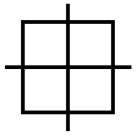



# Canudo<sup>®</sup>

## 과거의 아름다움을 담은 U형 기와



- 역사와 전통의 **지중해식 U형 기와**
- 역사적인 클래식한 지붕연출
- 역사적 지붕 복원에 사용

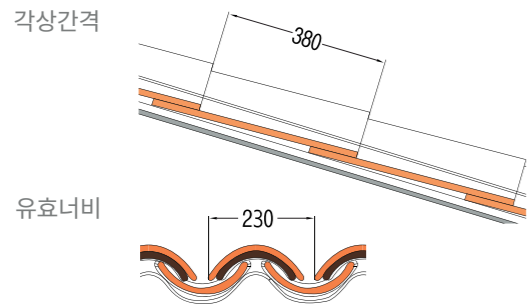

크기	450 x 200 / 150 mm
무게	2.2 Kg
각상간격	380 mm
유효너비	230 mm
㎡당 기와수	22 장
㎡당 무게	48.4 Kg
좌/우갓	2.6 장/m
용마루	2.6 장/m

## PRODUCT COLORS

제품 색상

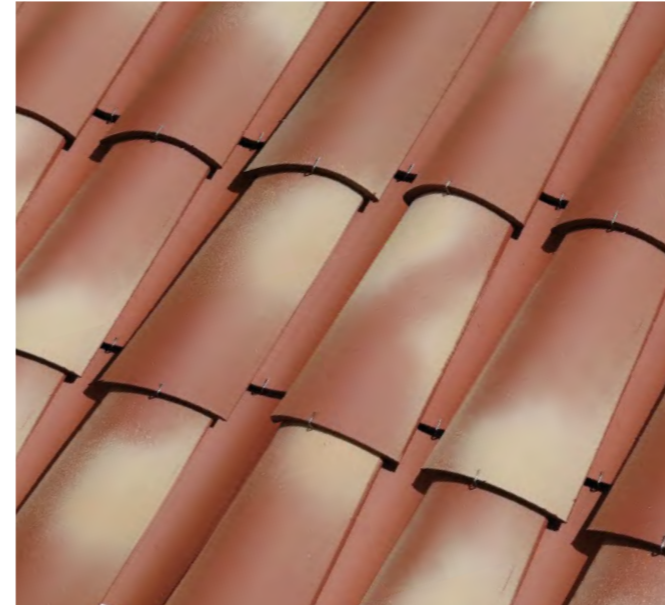

Europe 유포피언



Trentino 트렌티노

## PRODUCT SPECIFICATIONS

항목	적용기준	표준 요구사항
힘강도 Flexural strength	EN 538	저항>1000N
불침투성 Impermeability	EN 539-1	(Method 2) Category 1
동결저항성 Frost resistance	EN 539-2	유럽 단일 시험 방법 저항 - Level 1 (≤150 cycles)
동결저항성 Frost resistance	EN 1024	평면도≤1.5% 직선성≤2%

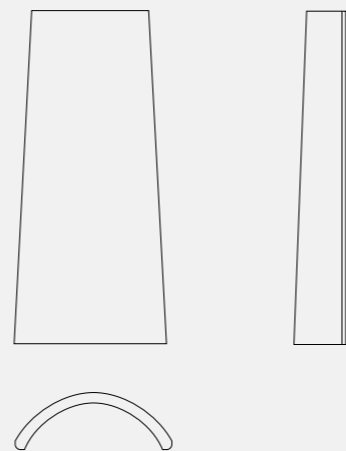

Toscana 토스카나



Natural Red 적색



**F3+** Nile 네일(70%) + Mediterranean Rustic 메디테리언(30%)



**F3+**

Natural Brown 밤색





F3+®

Vieille Terre 벨라테라



F3+®

Nile 네일





**F3+**®

Vieille Terre 벨라테라



**F3+**®

Nile 네일





F3+®

Nile 네일

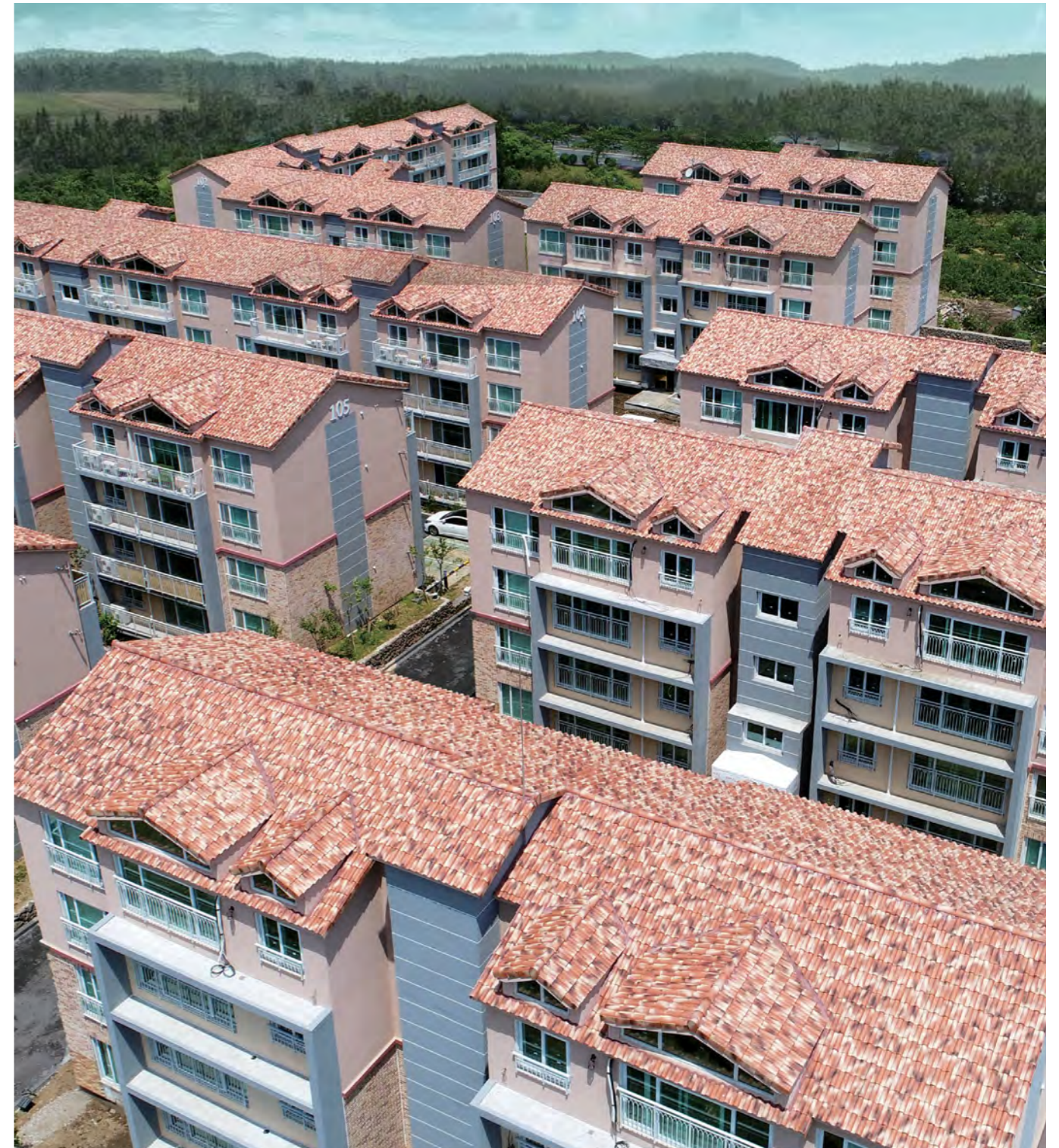



**F5**® *Global*

Rustic Natural 오지변색



**F5**® *Global*

Titanium 검정색





**D3+**®

Rustic Natural 오지변색





# Plasma®

Anthracite 검정색





# Plasma®

Anthracite 검정색





# Plasma<sup>®</sup> (↶) TX5

Slate 회색

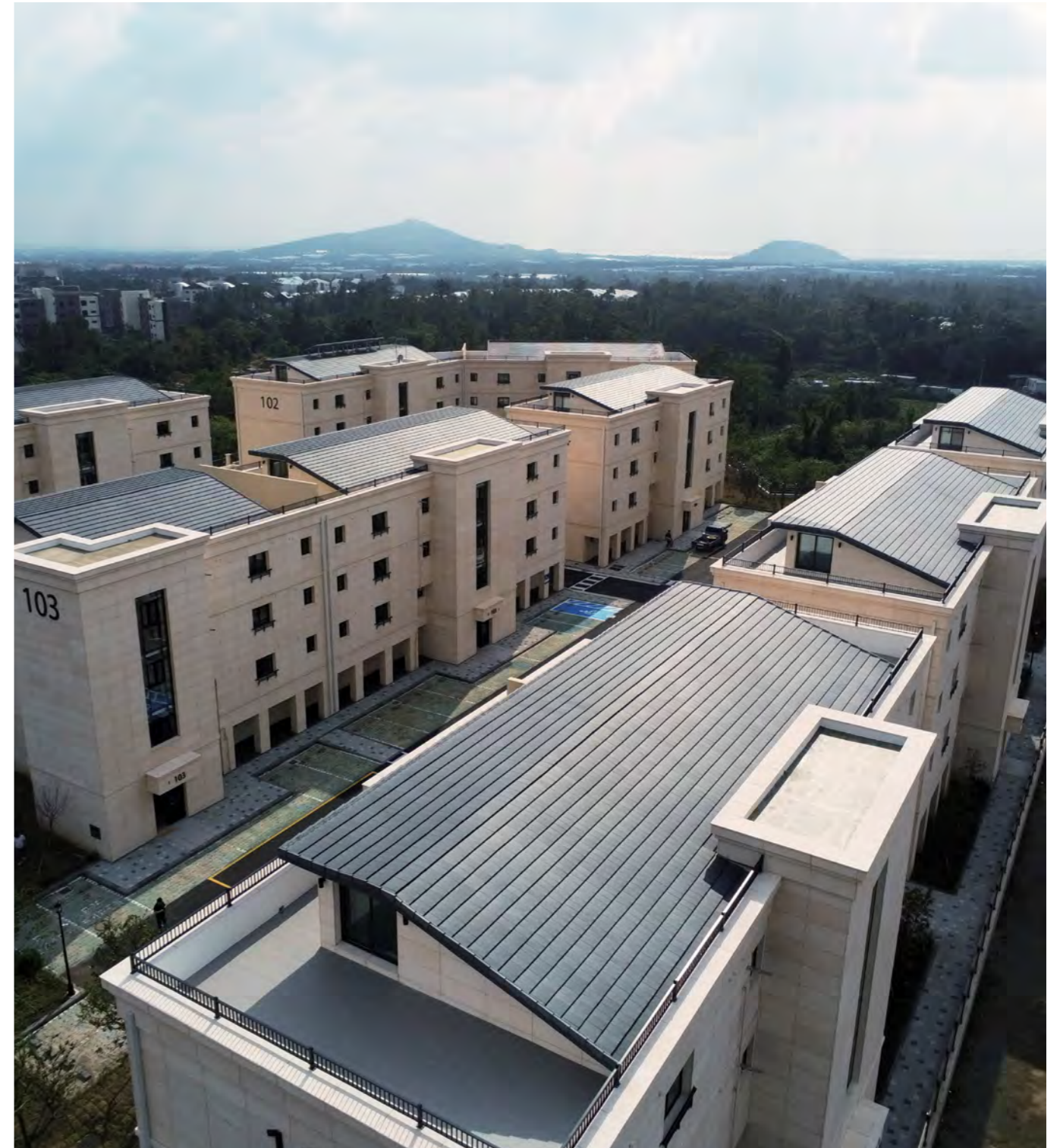



# Canudo<sup>®</sup>

Europe 유포어





# 부속기와

- ① 반기와 
  - ② 용마루 
  - ③ 박공마감 
  - ④ 좌갓 
  - ⑤ 우갓 
  - ⑥ 삼방향 
  - ⑦ 추녀마감 
  - ⑧ 차꼬 
- ※ 좌우바닥마감기와 (평기와 적용 부속) 

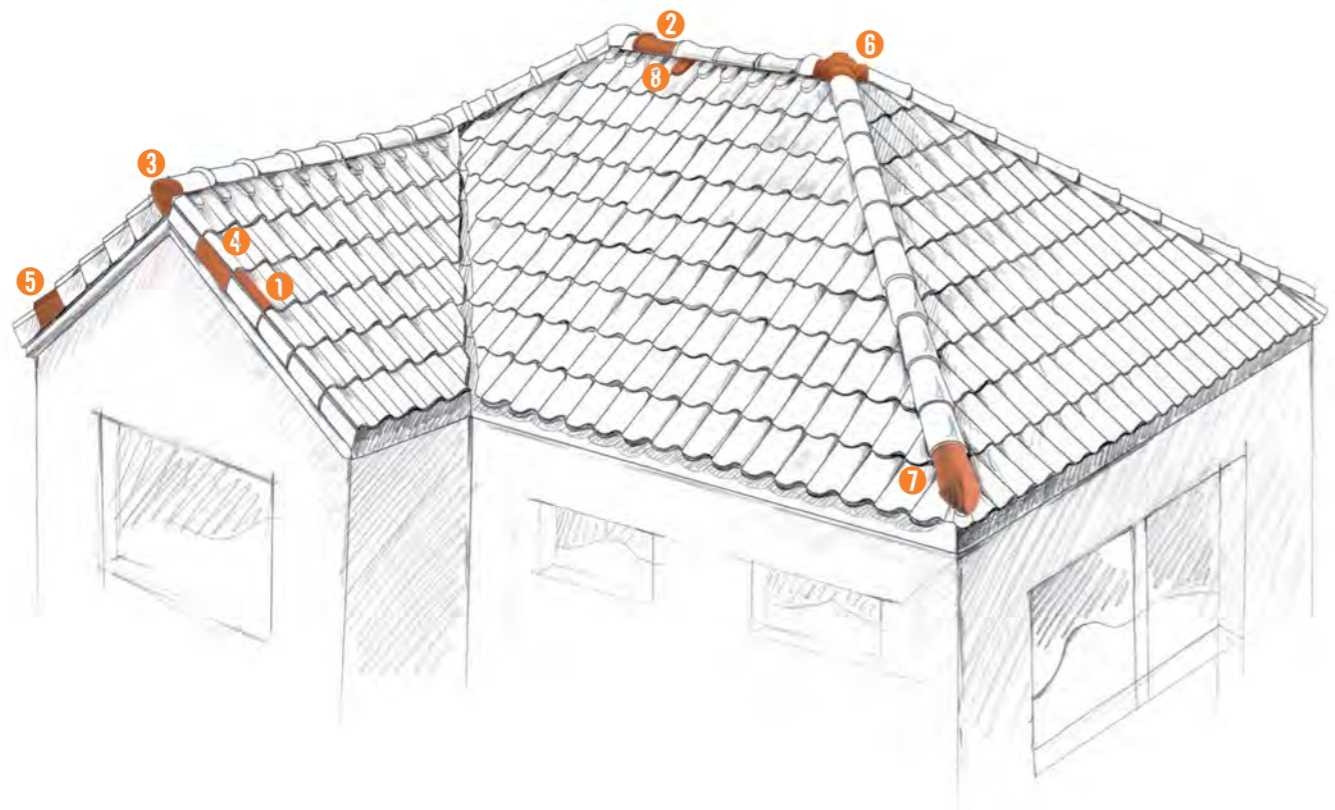

## F3+ F5 Global



## D3+



## Plasma

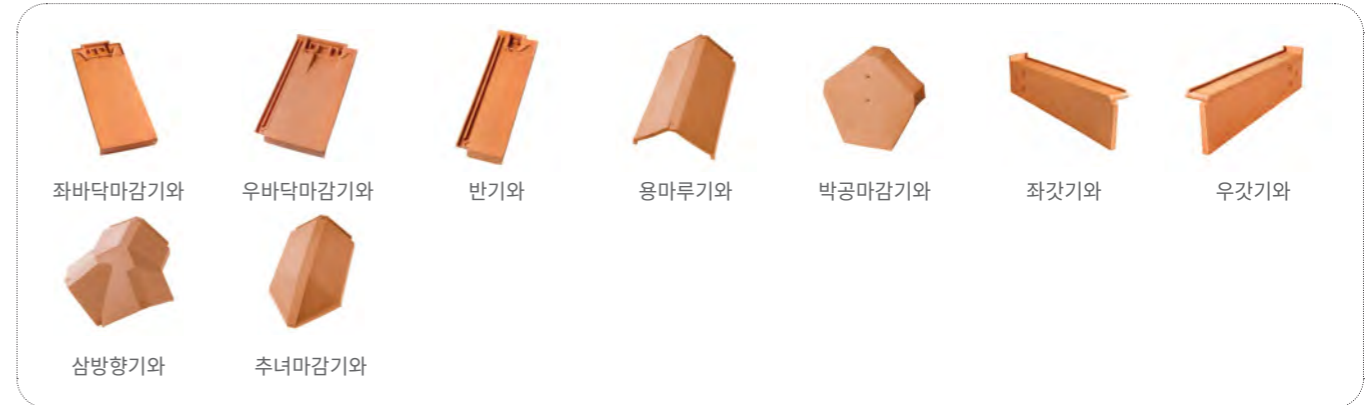

## Canudo

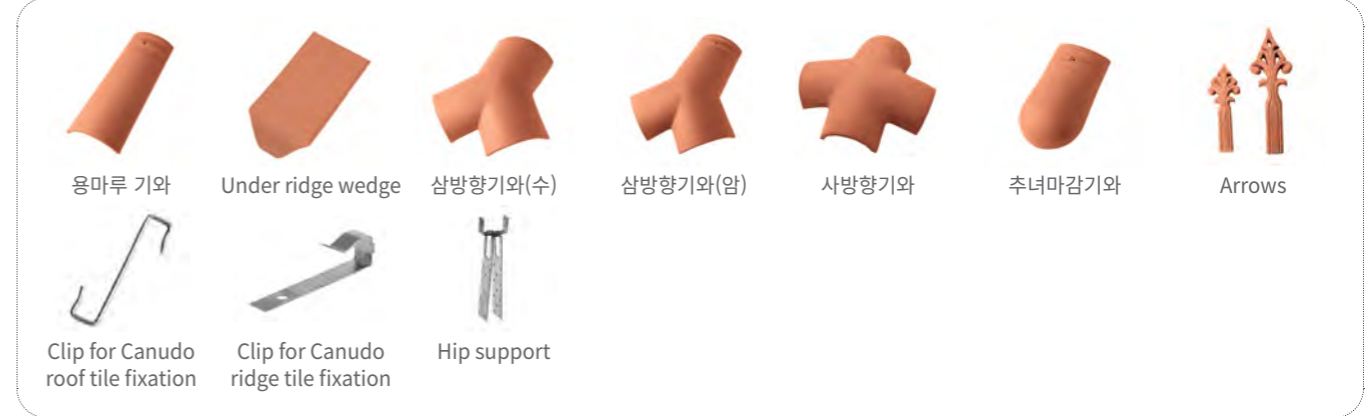

## CS기와 특별부속





## 부속자재

### 오웬스 코닝 방수시트 언더가드 프로



사이즈	1m(넓이) x 10m(길이)
원산지	국내
제조사	오웬스 코닝
포장	50 Roll / Pallet
표면적	면적 약 10m <sup>2</sup> / Roll

### 오웬스 코닝 방수시트 언더가드 S20



사이즈	1m(넓이) x 10m(길이) x 1.8 / 2.0mm
원산지	국내
제조사	오웬스 코닝
포장	50 Roll / Pallet
표면적	면적 약 10m <sup>2</sup> / Roll

### 각재



규격	수종	포장규격
20 x 30 x 3600 mm	소송, 스프러스(건조목)	16EA / 1단
30 x 30 x 3600 mm	소송, 스프러스(건조목)	12EA / 1단
42 x 42 x 3600 mm	미송, 스프러스(건조목)	6EA / 1단

### SNOW STOP

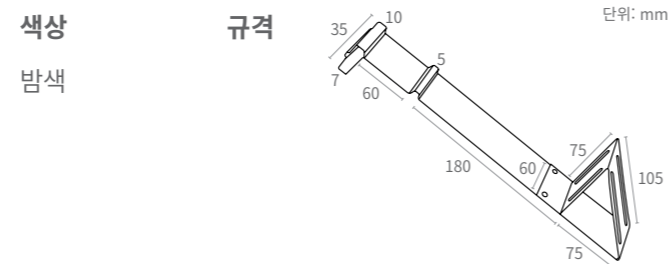

### JH 새막이 (Birdstop)



사이즈	1,010m(길이) x 75m(높이)
원산지	국내
색상	검정색
포장	100 EA / Box

### MDM 용마루 벤트

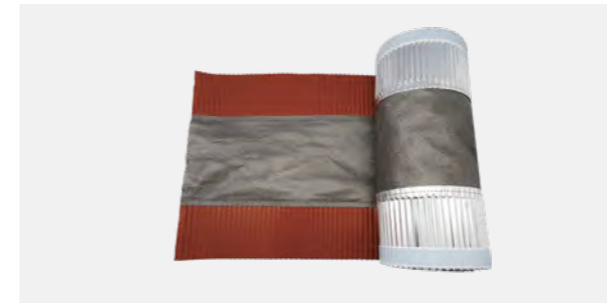

규격	390mm(넓이) x 5m(높이)
색상	적색, 검정색, 브라운
원산지	폴란드

#### · MDM 용마루 벤트 시공방법



### MDM EuroTec Flexx



규격	300mm(넓이) x 5m(높이)
색상	적색, 검정색, 브라운
원산지	폴란드

#### · MDM EuroTec Flexx 시공방법





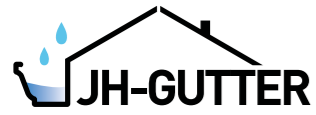

## 진흥 물받이 시스템

### 최신식 기계시설을 통한 최상의 제품 공급

집중 호우 등 기후 조건을 고려한 설계를 통해 안정적인 빗물 배수가 가능한 시스템으로, 특히 최신의 미국 설비 라인을 바탕으로 보다 정밀하고 균질한 제품을 완성하며, 다양한 제품과 색상으로 소비자가 원하는 지붕재 및 외장재와 조화를 잘 이룰 수 있습니다.



### 진흥 물받이 공용부속

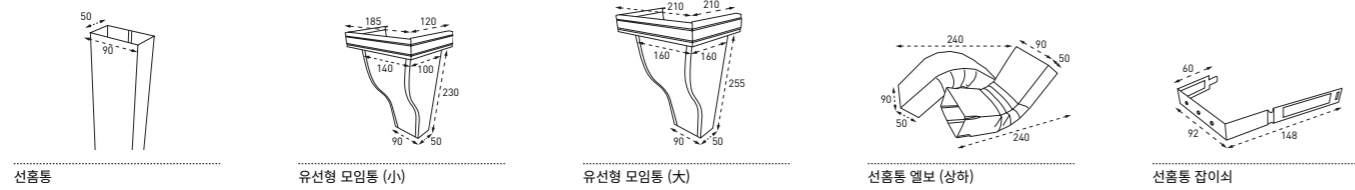

### K 300 300폭 물받이 시스템

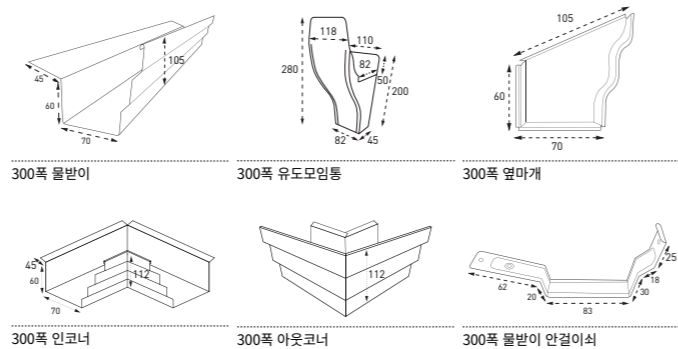
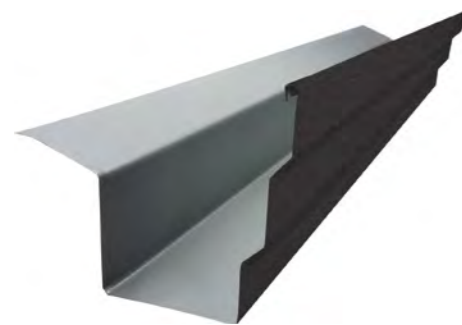

GI-X 101 진회색(무광)	GI-X 102 검정색(무광)	GI-X 103 브론즈(무광)	GI-X 104 네이비(무광)	GI-X 105 블루그레이(무광)	GI-X 201 부식 방색	GI-X 202 부식 녹색	GI-X 203 부식 검정색
GI-X 301 링클 회색	GI-X 302 링클 검정색	GI-X 303 링클 와인색	GI-X 304 링클 진회색	GI 등색	GI-X 백색	AL 방색	AL 백색

### EURO 300 300폭 물받이 시스템

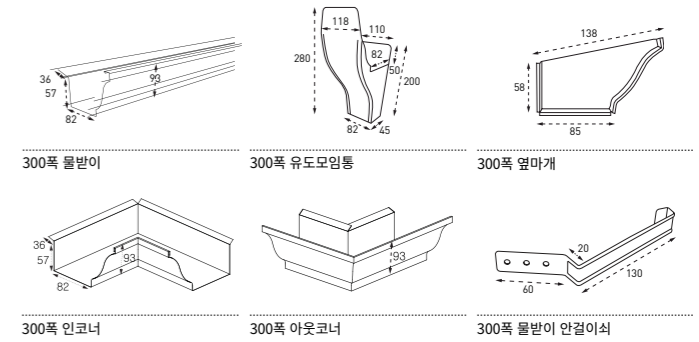
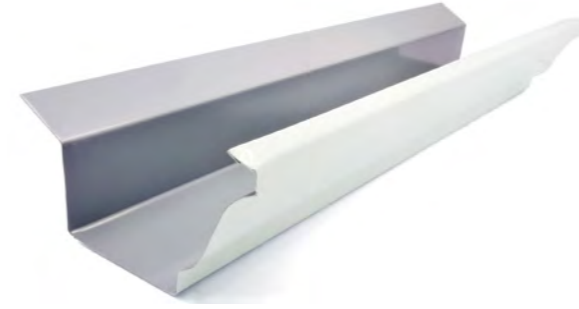

GI-X 101 진회색(무광)	GI-X 102 검정색(무광)	GI-X 103 브론즈(무광)	GI-X 104 네이비(무광)	GI-X 105 블루그레이(무광)	GI-X 201 부식 방색	GI-X 202 부식 녹색	GI-X 203 부식 검정색	GI-X 301 링클 회색
GI-X 302 링클 검정색	GI-X 303 링클 와인색	GI-X 304 링클 진회색	GI 등색	GI-X 백색	J-MAC 001 회색(무광)	J-MAC 002 진회색(무광)	J-MAC 003 검정색(무광)	JAL 201 슬리드 회색
JAL 202 슬리드 진회색	JAL 301 링클 검정색	JAL 302 링클 진회색	JAL 401 슬레이트 회색	JAL 402 슬레이트 방색	AL 방색	AL 백색	Premium JAL 001 그레이	Premium JAL 002 블랙
Premium JAL 003 레드	Premium JAL 004 블루	Premium JAL 005 그린	Premium JAL 006 진회색	Premium JAL 008 브라운	COPPER 동			

### EURO 380 380폭 물받이 시스템

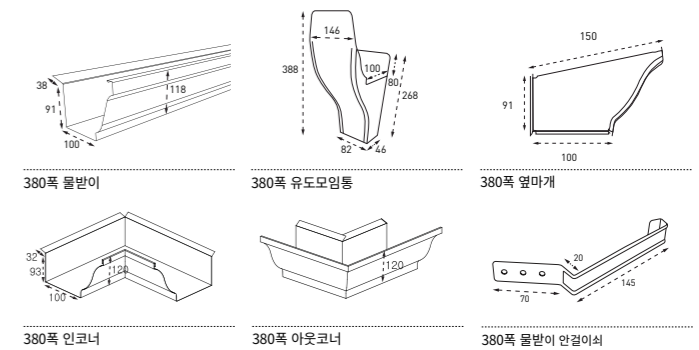
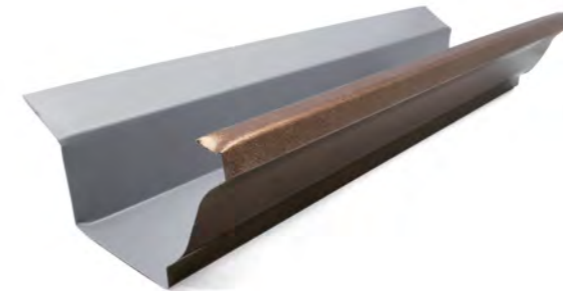

GI-X 201 부식 방색	GI-X 302 링클 검정색	AL 방색	AL 백색
-------------------	--------------------	----------	----------

### 포장규격



※진흥의 물받이 포장 박스

종류	수량
유도모임통 300폭	20 EA
유도모임통 380폭	10 EA
옆마개	20 EA
물받이 연결이쇠 小	30 EA
물받이 연결이쇠 大	120 EA
코너 물받이	10 EA
유선형 모임통 小	20 EA
유선형 모임통 大	10 EA
선흡통 엘보(상/하)	20 EA
선흡통 잡이쇠 小	20 EA
선흡통 잡이쇠 大	200 EA





## 기와 컷팅기

### 간편하고 안전하게 사용할수 있는 전문 기계

가벼운 무게와 컴팩트한 크기를 가진 기와 컷팅기는 직선, 대각선 문제 없이 컷팅이 가능하며, 넓은 지지대와 가벼운 무게로 기와 시공 시 지붕에서 직접 사용할 수 있습니다.



### 제품 사양

크기	480 x 170 mm (지지대)
무게	7 Kg
최대 절단 가능 두께	45 mm
원산지	이탈리아



### 부자재



#### 블레이드

두 개의 블레이드는 특수 열처리를 하여 탁월한 경도와 내구성을 보장합니다.



#### 스프링

기와 컷팅기의 부자재 중 하나인 스프링은 원활한 기와의 컷팅을 도와주는 부자재입니다.







JINHEUNG Company [www.jinheung.co.kr](http://www.jinheung.co.kr)  
Copyright © 2022 JINHEUNG Company. All Rights Reserved.

※ 본 카탈로그의 저작권은 (주)진흥인터내셔널에게 있습니다. 무단 전재와 무단 복제를 금합니다.  
※ 본 카탈로그의 색상은 인쇄용으로 실제 색상과 차이가 있을 수 있습니다.



Tel. 1644-2111 Fax. 031-8048-4878

마케팅 본부 : 경기도 용인시 기흥구 구성로357 용인테크노밸리B동1012호(청덕동556)

공장 / 물류센터 / 전시장 : 경기도 이천시 호법면 이십대천로 22-20(매곡리563)

공장 / 물류센터 : 경기도 고양시 덕양구 고양대로 1570(성사동296-3)